

# Easy Fuel Flow Meter AIC - 700 NEMO



- Accuracy better than 0.5 %
- Diesel, Gasoline, Bio-fuel, Light oil, Alcohol fuels consumption flow meter
- Temporary or permanent mount
- PT 1000 temperature probe for fuel consumption in volume and mass flow as well as CO2 exhaustion

The AIC - 700 NEMO flow meter has been designed for a permanent or temporary mount on vehicles with small engine compartment. Fast and intuitive installation.



### Applications:

- Diesel engine testing
- Small trucks
- Vans, mini-buses, mobilhomes
- Small agriculture and constructing machines
- Turbo-machinery development technology
- Compact sales tool to convince your customer to choose your vehicle

### Media that can be measured:

- Diesel, gasoline, bio-fuel, light oil, alcohol fuels, cooling agent

### Features and benefits:

- Highest accuracy for monitoring your equipment
- Small footprint and robust housing for shock protection
- New generation of mechanical flowmeters of proven technology since more than 40 years
- Excellent price-performance ratio
- AIC flow meters work on all fuel injection types including engines with fuel injection of latest generations

## System Setup

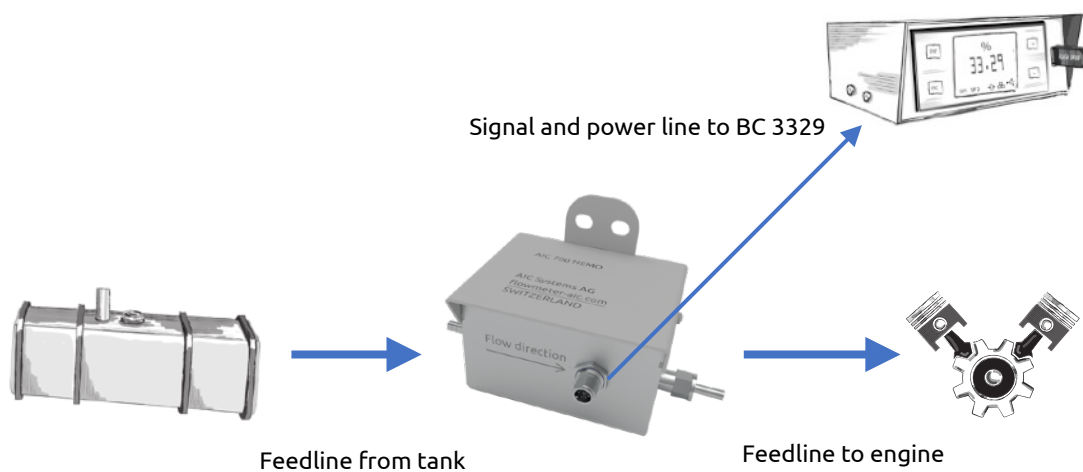

# Technology

## Rotary piston technology

After decades of experience, AIC SYSTEMS Ltd. has opted for the reliable volumetric flow meter technology. The rotary piston technology fits the fuel consumption measuring principle ideally. A single moving piston oscillates softly in a measuring chamber protected by a thin layer of fuel maintaining the piston self floating. This allows the meter to have the less possible mechanical friction, thus reduced wear. Under normal working conditions the line pressure loss ahead of the measuring cell is of max. 100 mbar.

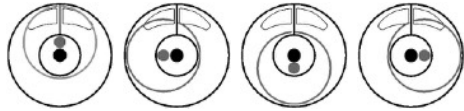

## Typical AIC 700 NEMO Installation

Flow Meter AIC 700



Signal cable 8282.10

Board computer BC 3329

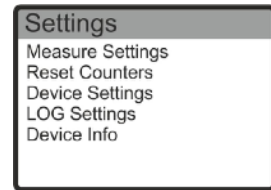
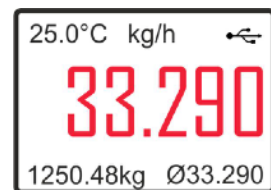

## Board Computer BC3329 NEMO

On the Board Computer BC3329 NEMO has in addition input for temperature and density. All measured values can be easily seen and written off the large display and are logged on the USB stick in CSV format. For further use mass calculation with manual density entry (according to DIN 51757).

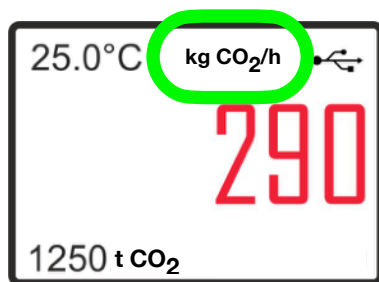

All data are available in the log file

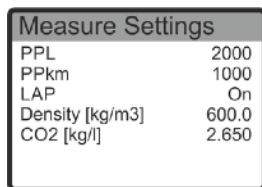
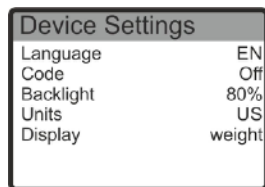

Type: BC3329									
Box #:	131								
FW Ver:	9.5								
PPL:	2000								
PPkm:	175								
Date:	Time:	current Consumption:	Temperature:	total Consumption:	O Consumption:	Speed:	O Speed:	ODO:	
22.5.19	07:57:09	149.6 l/h	40.5 °C	25003.7 l	148.6 l/h	2 km/h	1.7 km/h	11234 km	
22.5.19	07:57:11	149.2 l/h	40.6 °C	25003.7 l	148.6 l/h	2 km/h	1.7 km/h	11234 km	
22.5.19	07:57:13	148 l/h	40.6 °C	25003.8 l	148.6 l/h	3 km/h	1.7 km/h	11234 km	
22.5.19	07:57:15	148.5 l/h	40.5 °C	25003.9 l	148.6 l/h	4 km/h	1.7 km/h	11234 km	
22.5.19	07:57:17	148 l/h	40.5 °C	25004 l	148.6 l/h	6 km/h	1.7 km/h	11234 km	
22.5.19	07:57:19	149.1 l/h	40.5 °C	25004.1 l	148.6 l/h	8 km/h	1.7 km/h	11234 km	
22.5.19	07:57:21	147.9 l/h	40.5 °C	25004.2 l	148.6 l/h	10 km/h	1.7 km/h	11234 km	
22.5.19	07:57:23	145.9 l/h	40.5 °C	25004.2 l	148.6 l/h	12 km/h	1.7 km/h	11234 km	
22.5.19	07:57:27	145.9 l/h	40.5 °C	25004.3 l	148.6 l/h	10 km/h	1.7 km/h	11234 km	
22.5.19	07:57:29	149.9 l/h	40.5 °C	25004.5 l	148.6 l/h	10 km/h	1.7 km/h	11234 km	
22.5.19	07:57:31	147.6 l/h	40.5 °C	25004.6 l	148.6 l/h	10 km/h	1.7 km/h	11234 km	
22.5.19	07:57:33	150.2 l/h	40.3 °C	25004.7 l	148.6 l/h	10 km/h	1.7 km/h	11234 km	
22.5.19	07:57:35	149.5 l/h	40.3 °C	25004.7 l	148.6 l/h	10 km/h	1.7 km/h	11234 km	
22.5.19	07:57:37	147.6 l/h	40.4 °C	25004.8 l	148.6 l/h	10 km/h	1.7 km/h	11234 km	
22.5.19	07:57:39	146.6 l/h	40.4 °C	25004.9 l	148.6 l/h	10 km/h	1.7 km/h	11234 km	
22.5.19	07:57:41	148 l/h	40.4 °C	25005 l	148.6 l/h	10 km/h	1.7 km/h	11234 km	
22.5.19	07:57:43	145.2 l/h	40.4 °C	25005.1 l	148.6 l/h	10 km/h	1.7 km/h	11234 km	

## AIC 700 NEMO SET

AIC 700 NEMO Set is delivered in a protective transport case and consists of:

- AIC 700 NEMO
- BC 3329 NEMO
- Cabin stand
- 5m signal cable

Ordering number: 704.SET

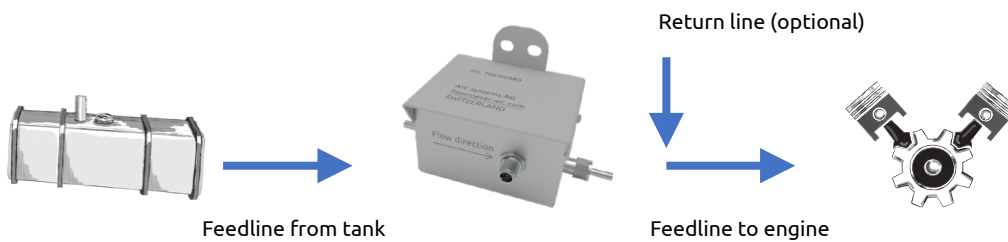
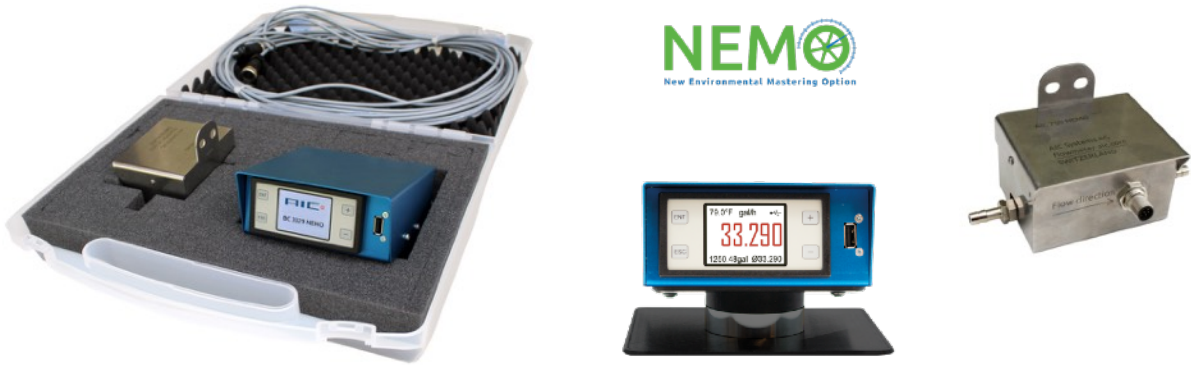

## Ordering structure

Model Type	Designation	Order code
AIC 700 NEMO	for engines with a Q max 21.1 gph _ 80 l/h or app. 300 HP	704
AIC 700 NEMO SET	Complete solution with 5 components for engines up to 300 hp	704.SET
Signal cables	Signal cable 10m (from AIC 700 to BC 3329)	8282.10
Connection kit	Standard connection kit with T-piece for return line	380 700
BC 3329 NEMO	Bord Computer BC 3329 <b>NEMO</b> for 20-28V DC No USB stick incl	3329.01
Presse Ride	Bord Computer 3329 <b>NEMO</b> for 20-28V AC/DC with 3m cable and a palm button, cabin stand is included without USB stick.	3329.10

## Technical data

### General Data

Manufacturer	AIC SYSTEMS AG
Product designation	AIC 704 NEMO

### Mechanical Data

Dimensions (l x w x h)	165 x 90 x 90 mm / 6.5 x 3.5 x 3.5 "
Weights	ca. 1.0 kg / 2.2 lb
Hydraulic nozzles connection	8,5 mm _ 1/3 "

### Materials

Flow meter - sensor	Brass, aluminium
O - rings	Viton™
Connectors	Steel protection TAAC3, stainless steel,
Housing	2 mm stainless steel 1.4301

### Flowmeter

Measurement principle	Volumetric, oscillating piston, with microprocessor controlled pulse emitter (Pat.AIC)
Measuring range	1 to 80 l/h _ 0.26 to 22 gph
Accuracy	±0.5 %
Repeatability	0.2%
Admissible pressure	-1 to 25 bar
Mounting position	Horizontal
Operating temperature	-30.....90 C°
Ingress protection	Sensor and electronic, IP 65

### Electrical connection

Power supply	8 - 28 VDC
Pulse signal	NPN open -collector; square 0.7 ms pulse width
Signal connector	M 12 / 8 pin

All informations are subject to change.



[www.flowmeter-aic.com](http://www.flowmeter-aic.com)

**AIC SYSTEMS AG**  
Ringstrasse 9  
4123 Allschwil  
**Switzerland**  
T +41 61 481 84 39  
[info@flowmeter-aic.com](mailto:info@flowmeter-aic.com)